

Integrating a LI-COR Trace Gas Analyzer with an LI-8100A/LI-8150 System

This application note provides instructions for integrating a LI-COR LI-7810 CH₄/CO₂/H₂O Analyzer into a LI-8100A Automated Soil CO₂ Flux System and LI-8150 Multiplexer system for the measurement of soil CH₄ fluxes. Although the LI-7810 is used in this demonstration, the instructions are generally the same for other analyzers in the LI-COR LI-78xx Trace Gas Analyzer platform.

Note: The following instructions apply only to the LI-8100A Automated Soil CO₂ Flux System, and not the legacy LI-8100 system. If you are interested in using a LI-COR Trace Gas Analyzer in your LI-8100 system, contact LI-COR technical support for more information.

We begin with an overview of plumbing, discuss software configuration and time synchronization, and conclude with instructions for downloading and merging data files in SoilFluxPro™ Software for CH₄ flux computation.

Plumbing Your System

The LI-7810 is plumbed into the LI-8100A system using the tubing and connectors from the Pneumatic Integration Kit (part number 9981-193). This kit includes:

- Quick-connect fittings (part numbers 300-07124, 300-07125) for connection to the LI-8100A.
- T-shaped connectors (part number 300-02627).
- Knurled compression fitting nuts (part number 300-05896), stainless steel inserts (300-18126), and ferrules (part number 300-15024) for connecting to LI-COR Trace Gas Analyzers.

all of which come pre-assembled on lengths of 1/4" outer-diameter Bev-A-Line® tubing.

The Pneumatic Integration Kit is a convenient option for configuring your system, but it is not required. You can plumb the system yourself with access to the proper components. You will also connect the instruments using the teal-colored Ethernet communications cable (part number 392-09436), which is included with every LI-8100A purchase.

Plumb your system by attaching the Pneumatic Integration Kit according to the following schematic.

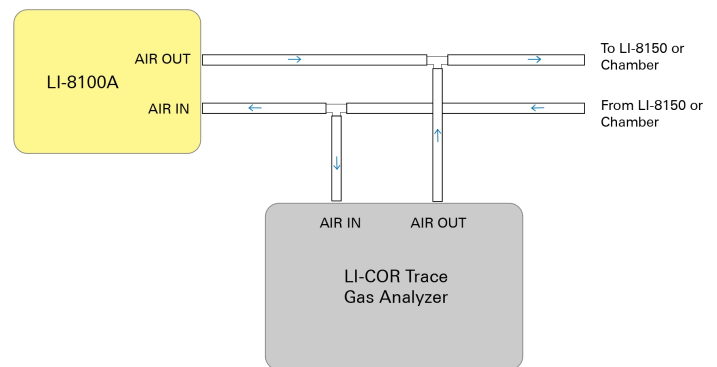

Note: While the LI-8100A and LI-8150 are weatherproof, the LI-7810 is not. You will need some field protection for long-term deployments, along with a suitable power supply. Refer to your analyzer user manual for power considerations.

Software Configuration

CH₄ data is stored in the LI-7810 and is not captured directly in your LI-8100A data files. The LI-8100A and the LI-7810 collect data in separate files, and the CH₄ data is then merged with the LI-8100A file by timestamp in SoilFluxPro Software for post-processing of fluxes. Because their data files are merged according to timestamp, synchronization of the LI-7810 and LI-8100A clocks is critical for accurately calculating fluxes.

This section begins with general software requirements, and continues with a discussion of clock synchronization and data collection for both instruments.



Software Version Requirements

First, check the version of the embedded software running your LI-8100A. You will need version 4.0.9 or newer. Launch the LI-8100A desktop software, connect to your LI-8100A, click **View**, and then **Instrument Status**.

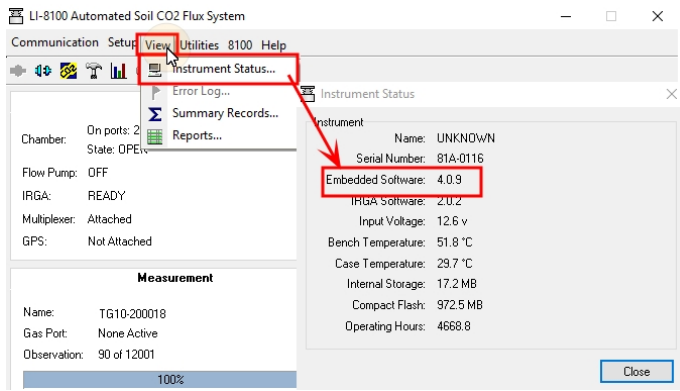
The **Embedded Software** version is displayed as the third item.



If you need to upgrade, you can find the installer at the LI-COR support site (licor.com/env/support). Navigate to **LI-8100A** and **Software** to find the installer. Instructions for updating your LI-8100A software can be found in the LI-8100A manual.

Next, you should check your LI-7810 software to make sure you are running version 2.0.8 or higher. Launch the LI-7810 web interface, click the cog icon , and then the **Network**  icon. Your **Software Version** will be displayed in the upper-left of the page.

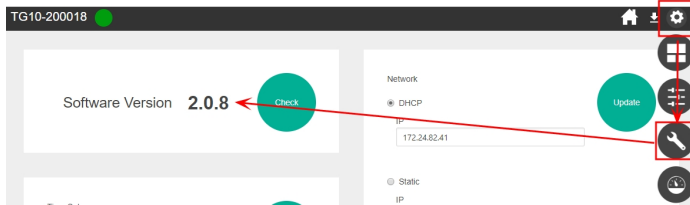

You can press **Check** to see if a new version is available. If you need to upgrade, follow the prompts in the software, or find software installers at the LI-COR support site. Instructions for updating can be found in the LI-7810 manual.

Time Synchronization



The following instructions demonstrate the networking features of both instruments and how they can be used to set static IP addresses to facilitate clock syncing.

First, connect to your LI-8100A using a serial cable and launch the desktop software. Click the **8100** tab, and select **Networking** to launch the **Remote Network Setup** screen.

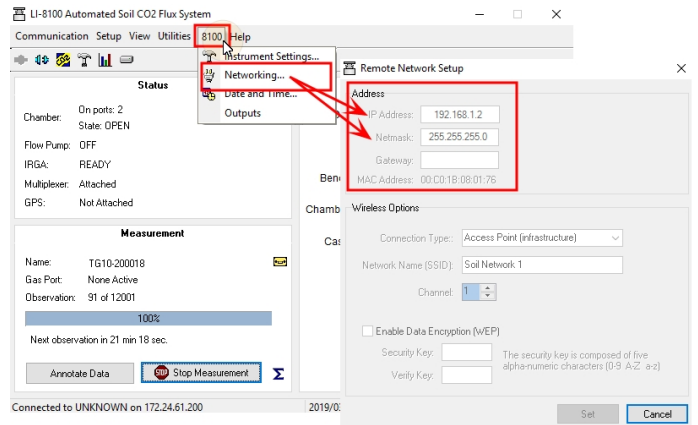
For a network connection directly between the LI-8100A and LI-7810, set the **IP Address** to 192.168.1.2 and the **Netmask** to 255.255.255.0. Leave the **Gateway** blank. Restart the LI-8100A after changing the IP Address.



Configure your LI-8100A soil CO₂ flux measurement as you normally would, and then start the measurement. For details, consult the LI-8100A manual.

Next, launch the LI-7810 software via Wi-Fi from your device of choice (see manual for software connection details). Click the cog icon  and then the **Network**  icon. In the **Networking** page, select the **Static** option. Set the **IP** to 192.168.1.1, and the **Subnet Mask** to 255.255.255.0. Press **Update** to save the settings.

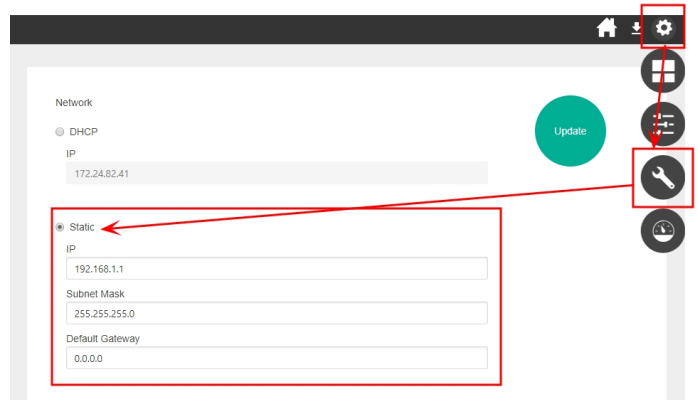

Next, on the same page of the software under **LI-8100** in the lower-left side of the screen, enter the static IP address of your LI-8100A that was set in a previous step.

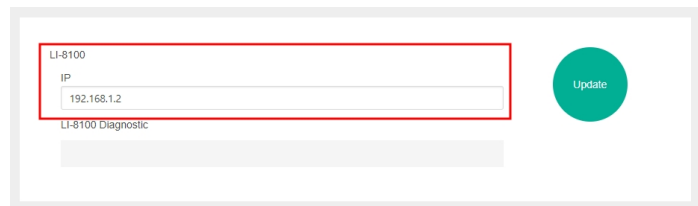

Now you can connect your LI-8100A and LI-7810 using the communications cable (part number 392-09436). Press **Update** to save the settings.

When you press **Update**, three things will happen.

- 1 The LI-7810 will stop the LI-8100A measurement.
- 2 The LI-7810 will synchronize the clock of the LI-8100A to the LI-7810 clock.
- 3 The LI-7810 will start a new LI-8100A measurement with a new file with the name `sn-yyyydoyhh.81x`, where `sn` is the LI-7810 serial number, `yyyy` is the year, `doy` is the day of the year, and `hh` is the the hour of the day.

Each night at midnight, these three events will be repeated. The LI-8100A daily data file generated by the LI-7810 will be stored on the LI-8100A internal storage first, and will be moved to the compact flash card memory at midnight after the new file is created and stored in the working memory.

Time Synchronization With a Local Network

The previous instructions for creating a remote network are intended for field settings where a local network is not available. If a local network is available at your research site, you can synchronize the instrument clocks over it. Ask your network administrator for a static IP address compatible with the local network, and enter it in the **Remote Network Setup** screen of the LI-8100A software as described above.

Then, in the **Networking** page of the LI-7810 software, enter this IP address in the **LI-8100 IP** field. The status of the communication between instruments is shown in the **LI-8100 Diagnostic** field.

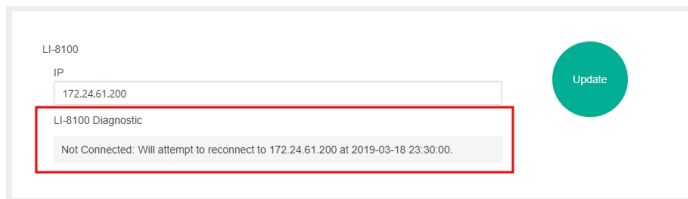

Downloading Data Files

First, launch the LI-8100A desktop software. Click the drive icon to launch the **File Manager**.

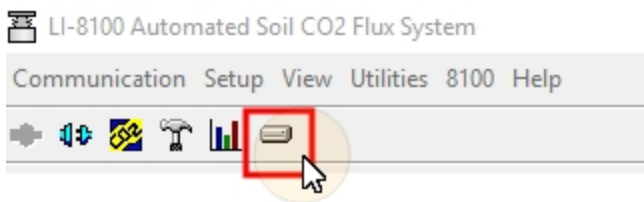

From the **File Manager**, you can select a folder on your computer to which you can download your files. Recall that your daily files are first saved to the **Internal Storage**, but are transferred to the **Compact Flash Card** memory each night at

midnight when a new daily file is created. Select your daily LI-8100A data files and press **Transfer to PC**.

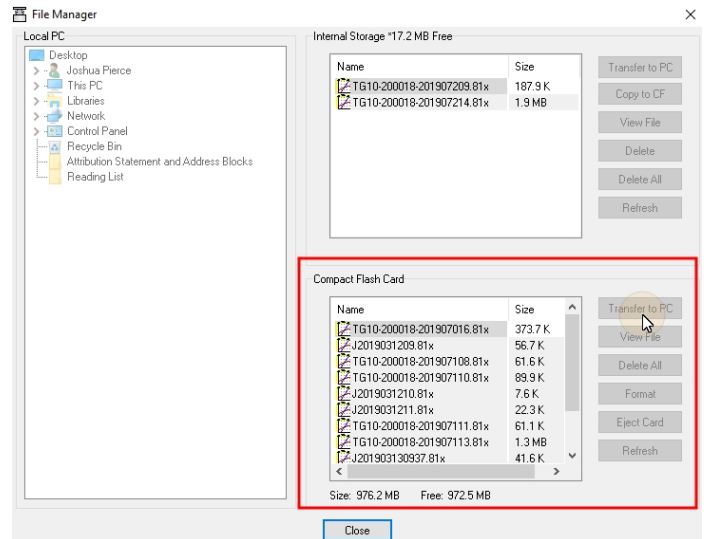

Next, launch the LI-7810 software. Press the **Download** icon at the top right portion of the screen. This will open a new window where you must specify the start and end date and times for your measurements. Press **Export** and your data file will be downloaded to the destination that is set through your internet browser.

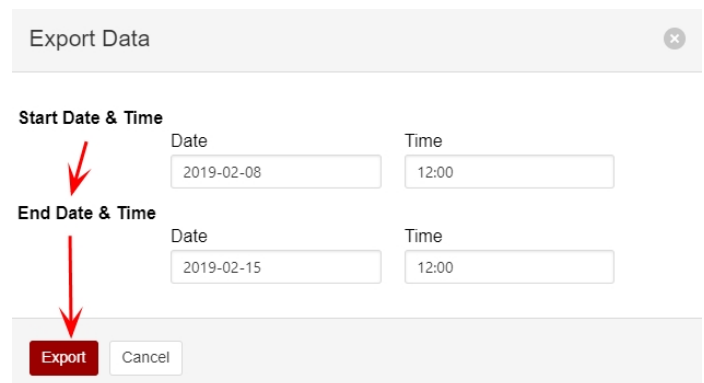

The LI-7810 outputs data in a text format with a `.data` extension. If you open the file in a spreadsheet software, you will see the following.

	A	B	C	D	E	F	G	H	I	J
Model:		LI-7810								
SN:		TG10-200018								
Software Version:		2.0.6								
Timestamp:		3/4/2019 14:00								
Timezone:		US/Central								
DATAH	SECONDS	DIAG	DATE	TIME	H2O	CO2	CH4	CAVITY_P	CAVITY_T	
DATAU	secs	diag	date	time	ppm	ppm	ppb	kPa	°C	
DATA	1551729600	0	3/4/2019	14:00:00	11007.7	872.339	2639.79	41.0157	54.9995	
DATA	1551729601	0	3/4/2019	14:00:01	11044	871.62	2639.66	41.0166	54.9995	
DATA	1551729602	0	3/4/2019	14:00:02	11079	871.978	2639.7	41.0157	54.9995	
DATA	1551729603	0	3/4/2019	14:00:03	11115	871.721	2639.64	41.0145	54.9995	
DATA	1551729604	0	3/4/2019	14:00:04	11149.2	873.503	2639.76	41.0149	54.9995	
DATA	1551729605	0	3/4/2019	14:00:05	11182.4	873.206	2639.61	41.0153	54.9995	
DATA	1551729606	0	3/4/2019	14:00:06	11216.1	872.646	2639.52	41.0145	54.9995	
DATA	1551729607	0	3/4/2019	14:00:07	11250.5	872.958	2639.43	41.0149	54.9995	
DATA	1551729608	0	3/4/2019	14:00:08	11283.3	873.753	2639.4	41.0149	54.9995	

For this demonstration, we are most interested in the date (mm/dd/yyyy), time (hh:mm:ss), and the CH₄ concentration

(nmol mol⁻¹ or ppb) data (columns D, E, and H, respectively). However, the LI-7810 also records CO₂ (μmol mol⁻¹ or ppm) and H₂O concentration data (μmol mol⁻¹), as is shown in the file above (columns G and F, respectively).

Merging Data in SoilFluxPro Software

SoilFluxPro is used to calculate fluxes using data collected from both instruments. Beginning with your daily LI-8100A .81x files, the **Column Import Routine** is used to import the CH₄ concentration data columns from your LI-7810 files into the .81x file, so that fluxes can be computed from a single file with columns for both gases.

First, if you don't have it installed already, you should download SoilFluxPro from the LI-COR support site (licor.com/env/support). Select **SoilFluxPro** and then **Software** to find the installer for your operating system. If you already have SoilFluxPro installed, check the top bar in the main window to make sure you are using version 4.2 or newer.

Start the merging process by opening all of your daily LI-8100A data files in SoilFluxPro. You can open several files at once and combine them into a single file. Select **File, Open**, navigate to the directory with the daily .81x files you transferred from your LI-8100A, select all of them, and click **Open** again. You will be prompted with a message. Click **Yes**.

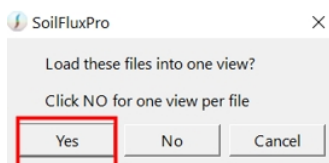

Start the Column Import Routine by clicking the **Import** icon. In the window that opens, open the **File Format** list and choose **LI-COR LI-78xx**.

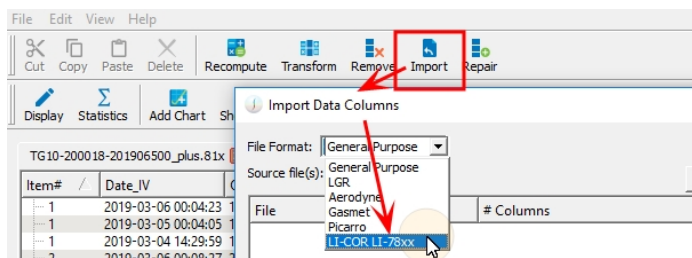

Next, select **Add files...** and select your LI-7810 .data file that you downloaded earlier. Click **Open**. SoilFluxPro will parse your .data file and search for the time stamps that match the time stamps in the .81x data file. The green **ok** text fields on the right hand side indicate that SoilFluxPro recognizes the fields in your .data file while parsing and that you are clear to import columns.

In the lower left of the dialog in the **Check column labels to import** window, check the boxes for the columns you want to

import. from the .data file. In this case, we select the CH₄ column:

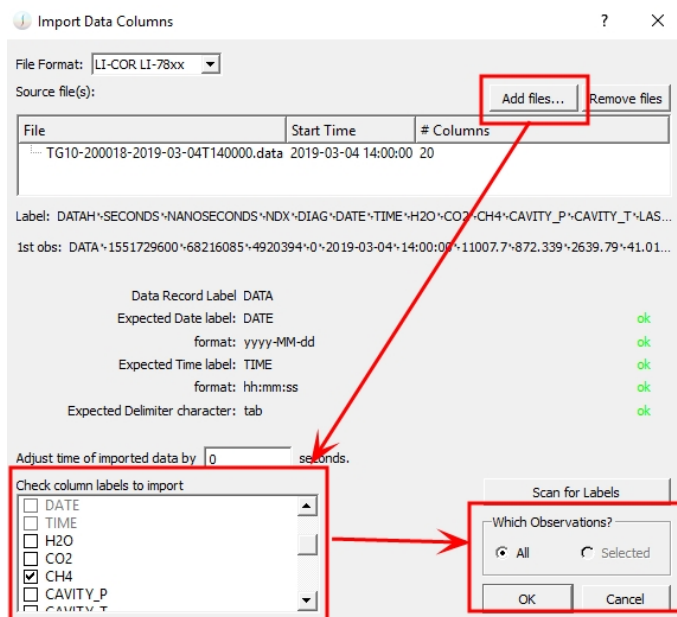

You may also consider importing status codes or diagnostic information from the LI-7810 file so that you can assess whether your measurements are valid and that no errors were present during the data collection.

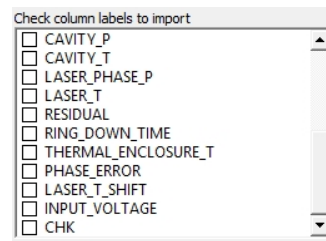

Leave the radio button for **All** observations checked, and press **OK**. Import may take a few moments. Then, you will see a note in the log that the observations were imported:

```
135 observations read into view TG10-200018-701906500_plus.81x
135 observations successfully imported columns
```

Calculating CH₄ Fluxes Using LI-7810 Data

After the CH₄ data has been merged into a single .81x data file, you can calculate fluxes for gases measured by both instruments. Press the **Recompute** icon to begin.

Before adding a new gas column for CH₄ fluxes, you should account for the volume contributed by the LI-7810 into your total system volume on the *Cdry* tab - the gas column used to compute CO₂ fluxes with LI-8100A data. Check the box next to *Virga* and change the value from 19 to 66 cm³ (where 66 cm³ = 19 cm³ for the existing LI-8100A *Virga* + 19 cm³ added by the tubing in the Pneumatic Integration Kit + 28 cm³ added by the LI-7810 cavity).

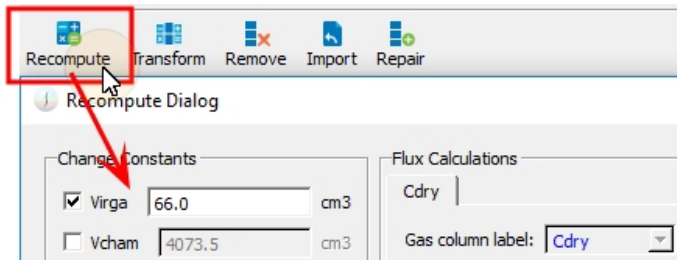

Next, follow these instructions to create a new gas column ID label for computing CH₄ fluxes with the data imported from the LI-7810. Since the CH₄ gas concentration was reported in dry mole fraction, additional water vapor dilution correction is not needed.

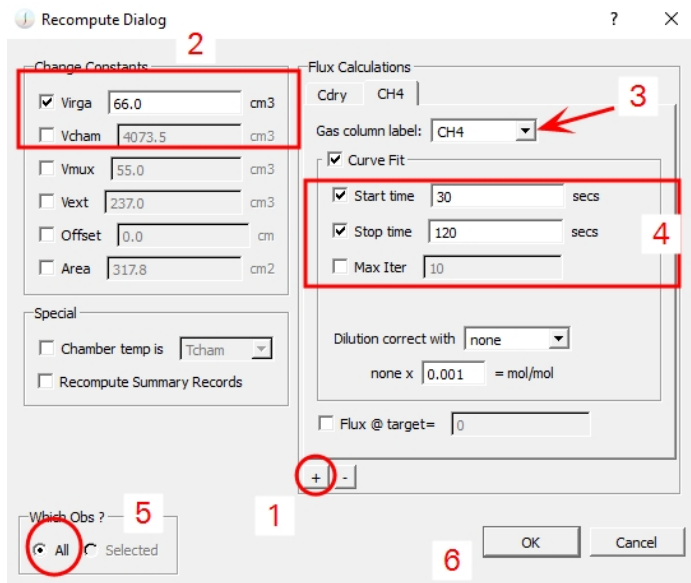

- 1 Select the plus sign to add a new tab to the Flux Calculations window.
- 2 Check the box next to *Virga* and change the value from 19 to 66 cm³, just as you did for the *Cdry* tab in a previous step. This ensures you are using the same system volume to calculate fluxes with the CO₂ data from the LI-8100A and the CH₄ data from the LI-7810.
- 3 Choose your **Gas column label** (in this case, CH₄ that was imported from the LI-7810 file). The gas column label name will become the name of the new tab.
- 4 Set the start and stop times you want to use for your flux computation.
- 5 Select **All** observations.
- 6 Click **OK**.

After recomputing, you can adjust the displayed variables to view your flux variables for each observation. Click the **Display** icon. To display the exponential flux for CH₄, navigate to the **Ftr** tab. Under **Gas # (usually 1)**, select **2**. This will allow you to add the *Exp_Flux* variable for the second gas column ID you created in the previous step. Grab the *Exp_Flux*

variable, and drag it into the **Items to be included** window. You will see that it becomes *Exp_Flux[2]*.

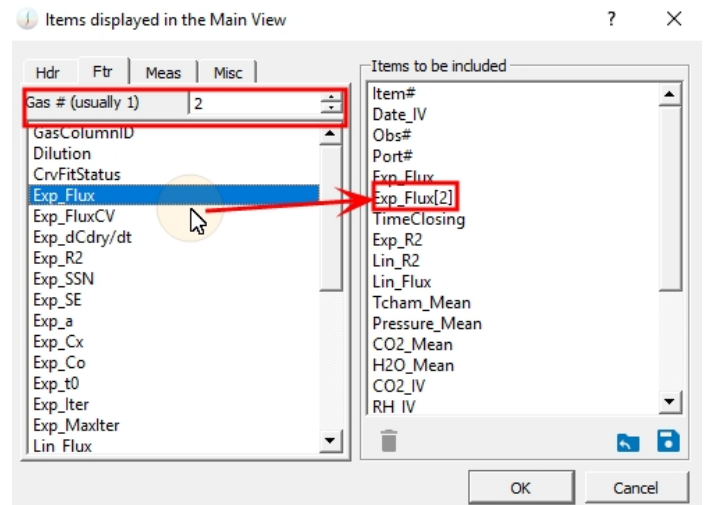

Press **OK**, and *Exp_Flux[2]* will be visible in the main screen.

Item#	Date_IV	Exp_Flux	Exp_Flux[2]	Lin_Flux	Lin_Flux[2]
* 1	2019-03-04 14:29:59	3.81649	1.48756	2.12099	0.316682
* 2	2019-03-04 14:34:04	1.42844	-0.166656	1.00891	-0.166656
* 3	2019-03-04 14:54:03	3.2348	0.507867	2.00508	0.152689
* 4	2019-03-04 15:14:03	3.5222	-5.69041	2.11601	-1.30276
* 5	2019-03-04 15:34:03	2.83808	-0.0362522	1.84737	-0.0362522
* 6	2019-03-04 15:54:03	2.79637	1.67177	1.74986	0.630925
* 7	2019-03-04 16:14:03	3.11863	-4.209	1.79354	-1.12219
* 8	2019-03-04 16:34:03	3.41502	-0.0377012	2.06293	-0.0377012
* 9	2019-03-04 16:54:03	3.70392	-0.114372	2.02826	-0.114372
* 10	2019-03-04 17:14:03	3.6825	-0.33636	2.18818	-0.33636
* 11	2019-03-04 17:34:03	3.2984	-1.23407	2.11124	-0.339568
* 12	2019-03-04 17:54:03	2.96859	-0.590311	1.84771	-0.168366
* 13	2019-03-04 18:14:03	2.9651	-0.661438	1.91211	-0.115121
* 14	2019-03-04 18:34:03	2.84045	-0.667967	1.78683	-0.203298
* 15	2019-03-04 18:54:03	2.69021	-1.08069	1.84479	-0.168243
* 16	2019-03-04 19:14:03	2.89388	0.267322	1.92866	0.267322
* 17	2019-03-04 19:34:03	3.00562	-0.268766	1.77487	-0.268766
* 18	2019-03-04 19:54:03	2.75691	-0.747568	1.78366	-0.154829

Exponential CO₂ flux from LI-8100A
Exponential CH₄ flux from LI-7810
Linear CO₂ flux from LI-8100A
Linear CH₄ flux from LI-7810

You may also choose to import CO₂ data from the LI-7810 and calculate fluxes from it. In the **Import Data Columns** screen, check the box next to the CO₂ column, and repeat the process in the **Recompute Dialog** to create an additional **Gas column label** for the LI-7810 CO₂. When you drag the new, third *Exp_Flux* or *Lin_Flux* variables to the **Items to be included** window, they will be displayed as *Exp_Flux[3]* or *Lin_Flux[3]*, respectively. This is shown in the image above.

Lastly, you can double click an observation to launch the **Observation Details** window for the observation. Click the **Fit#2 CH₄ ppb** tab to view details about the newly-calculated CH₄ flux.

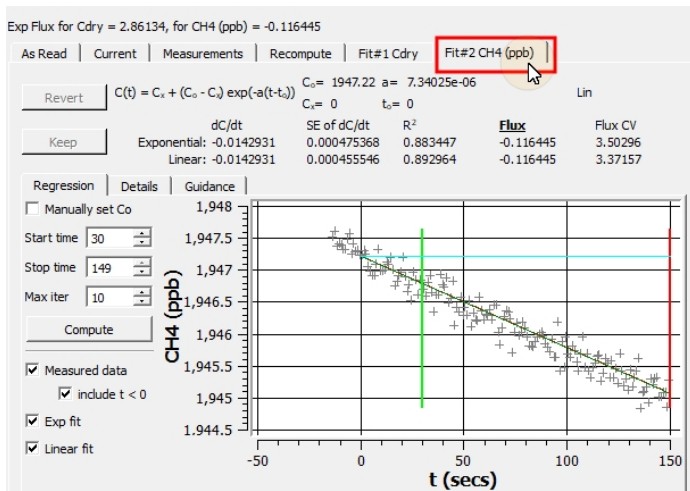

With your fluxes recomputed, the dataset can be analyzed further with SoilFluxPro or exported for analysis with a different software. A complete instruction manual for SoilFluxPro is available at the LI-COR support site (licor.com/env/support).

Sample CO₂ and CH₄ Flux Data

This above procedure demonstrated how to calculate CH₄ fluxes using data from the LI-7810. The LI-7810 also calculates CO₂ concentration, and you may choose to use it for flux calculations, but our research suggests that this is not necessary, and that CO₂ flux data are consistent and reliable from either or both instrument(s).

To test this, an LI-7810 was integrated into a multiplexed LI-8100A and LI-8150 system at the LI-COR campus in Lincoln, NE, USA from 31 August, 2018 to 10 January, 2019.

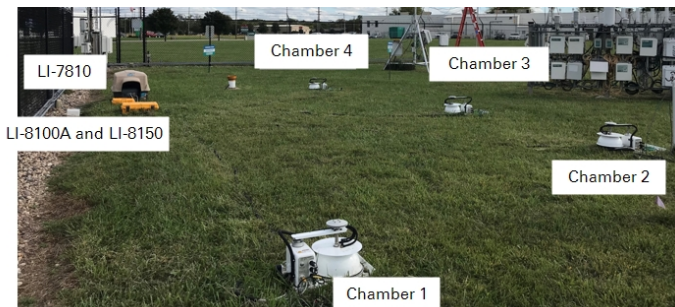

We compared the exponential CO₂ flux from the LI-8100A with the exponential CO₂ flux from LI-7810.

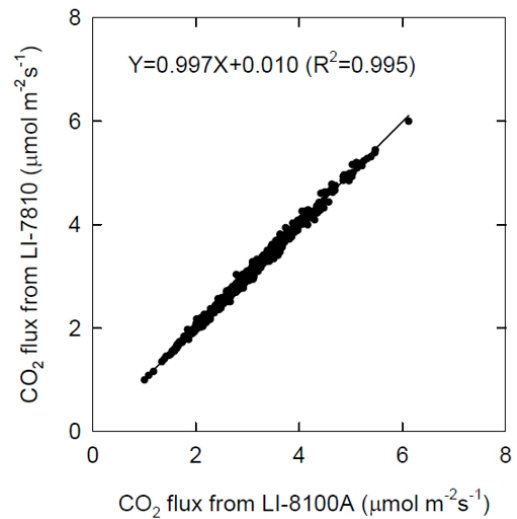

The figure above shows a comparison (from Sept 13-19, 2018) which has a linear slope of 0.997 and regression coefficient of 0.995.

Soil CH₄ flux for chamber 2 from DOY 250 to 330 of 2018 is shown in the figure below.

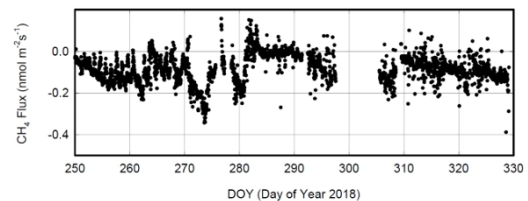

Because of microbial oxidation, the soil is normally a CH₄ sink with a typical rate of $-0.2 \text{ nmol m}^{-2}\text{s}^{-1}$ with a maximum rate of around $-0.35 \text{ nmol m}^{-2}\text{s}^{-1}$. This is expected and consistent with published rates in the literature (e.g. Ueyama, et al. 2015). An example of CH₄ time series data for one observation is shown below.

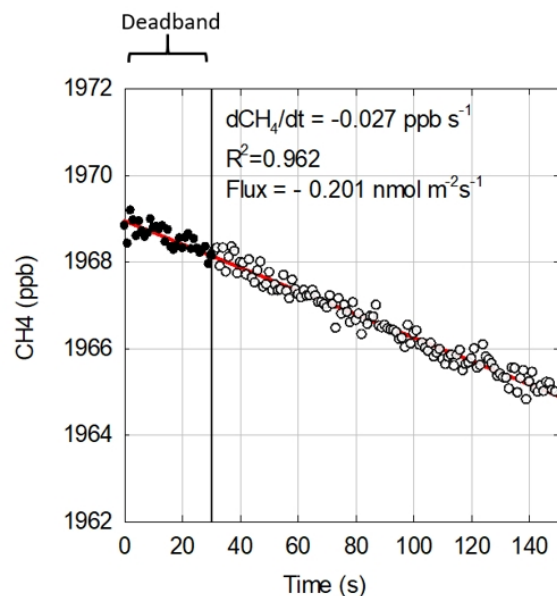

This example shows that during the 2.5-minute chamber closure period, the CH₄ concentration inside the chamber gradually decreased with a linear slope of -0.027 ppb s⁻¹ and a flux of -0.201 nmol m⁻²s⁻¹.

Minimum Detectable Soil CH₄ Flux

Based on our seasonal, long-term CH₄ flux data, we feel confident that this configuration of a closed chamber system with LI-7810 analyzer can resolve a minimum flux as low as 0.05 nmol m⁻²s⁻¹. See an example below.

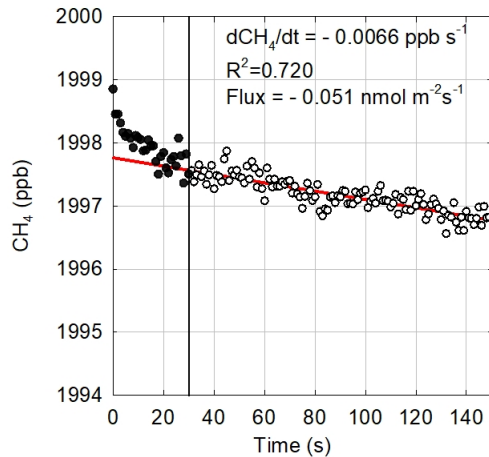

Over the two-minute observation, chamber CH₄ concentration decreased by approximately 0.79 ppb (0.0066 ppb s⁻¹ × 120 seconds = 0.792 ppb). This is roughly 3 times the precision of the LI-7810 analyzer (~0.25 ppb), giving us confidence in the slope estimation using linear or exponential regression.

References

Ueyama M., et al., 2015. Methane uptake in a temperate forest soil using continuous closed-chamber measurement. *Agricultural and Forest Meteorology*. 213:1-9.



LI-COR Biosciences

4647 Superior Street
Lincoln, Nebraska 68504
Phone: +1-402-467-3576
Toll free: 800-447-3576 (U.S. and Canada)
envsales@licor.com

LI-COR Distributor Network

www.licor.com/env/distributors

Regional Offices

LI-COR Biosciences GmbH

Siemensstraße 25A
61352 Bad Homburg
Germany
Phone: +49 (0) 6172 17 17 771
envsales-gmbh@licor.com

LI-COR Biosciences UK Ltd.

St. John's Innovation Centre
Cowley Road
Cambridge
CB4 0WS
United Kingdom
Phone: +44 (0) 1223 422102
envsales-UK@licor.com